

Data sheet | Item number: 750-492/040-001

2-channel analog input; 2- to 4-conductor connection; Differential input;
NAMUR NE 43; Extreme

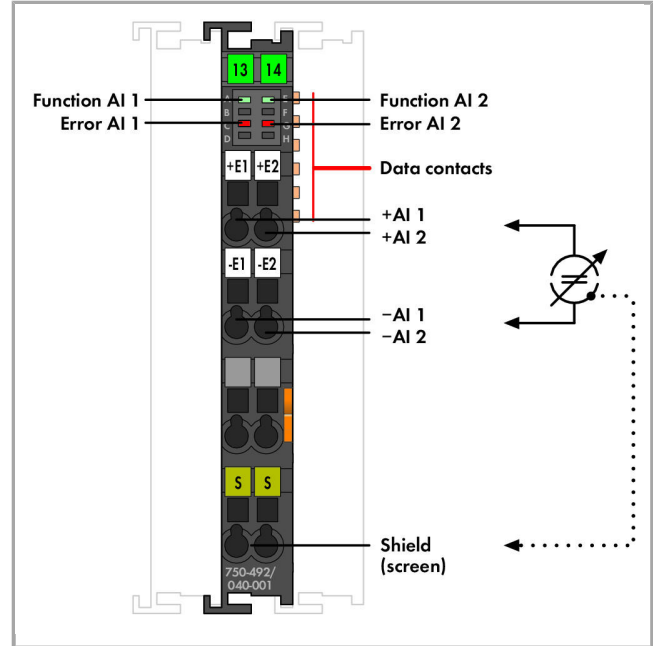

750-492/040-001



RoHS Compliant

[BOMcheck.net](https://www.bomcheck.net)

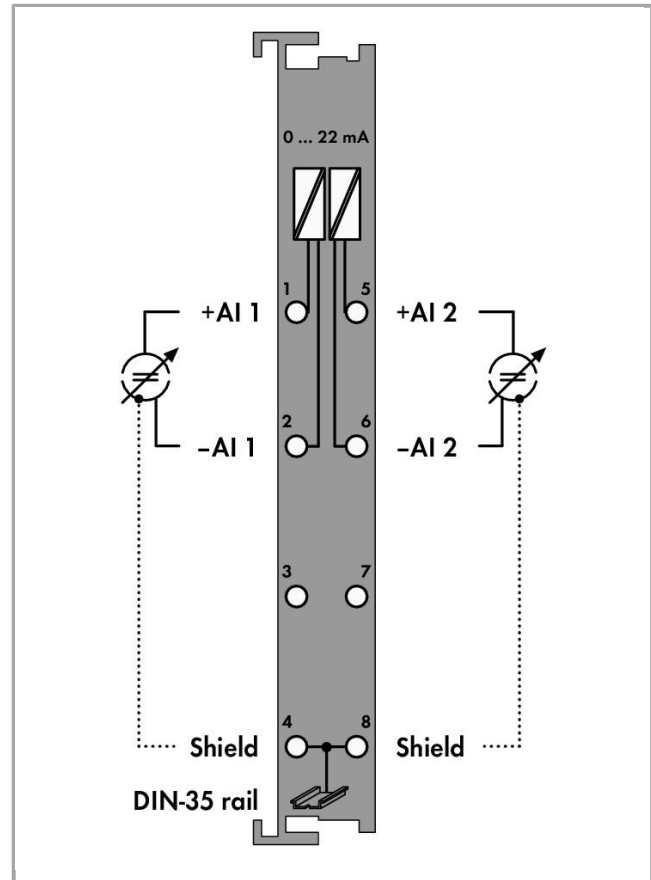
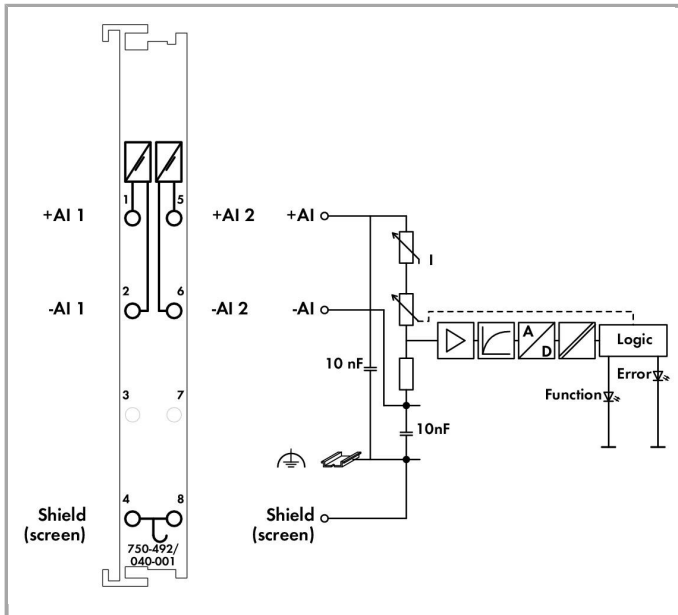

Item description

This 2-channel analog input module processes differential signals ranging from 4–20 mA.

The input signal is transmitted with a resolution of 13 bits.

The channels are electrically isolated from one another and from the system level.

The system supply powers the module.

The shield (screen) is directly connected to the DIN-rail.

- Measured value acquisition: time synchronous (both inputs)
- Measurement range overflow/underflow: status byte and LED
- Conversion method: SAR (Successive Approximation Register)
- Operating mode: continuously sampling (default)
- Protection: non-linear limiting

The device is ideal for operation in extreme environments:

- Extended temperature range
- Greater immunity to impulse voltages and electromagnetic interference
- Higher vibration and shock resistance

Data

Technical Data

Number of analog inputs	2
Total number of channels (module)	2
Type of signal	Current
Type of signal current	DC 4 ... 20 mA
Sensor connection	2 x (2-conductor)
Input filter	low pass first order, $f_G = 5$ kHz
Signal characteristic	Differential
Resolution [bit]	13 Bit
Operating mode	Triggered (Preset)
Input resistance max.	270 Ω
Bit width	2 x 16-bit data; 2 x 8-bit control/status (optional)
Protection	Non-linear limiting
Crosstalk attenuation	80 dB
Monotonicity without missing codes	Yes
Messfehler, Bezugstemperatur	25 °C
Messfehler, Abweichung max. vom Messbereichsendwert	0.1 %
Error in complete temperature range	$\leq 0,4$ %
Temperaturfehler max. vom Messbereichsendwert	0.01 %/K
Sampling duration	5 μ s
Sampling delay (channel/channel)	1 μ s
Sampling delay (module)	1 ms
Sampling time of repetition	1 ms
Measuring range overflow/underflow	Status byte and LED
Measured-value acquisition	Time synchronous (both inputs)
Value of the LSB (least significant bit)	2 μ A
Method of conversion	SAR (Successive Approximation Register)
System supply voltage	DC 5 V; via data contacts
Current consumption, system supply (5 V)	80 mA
System and sensor supply voltage)
Dielectric strength	AC 510 V/DC 775 V; gemäß EN 60870-2-1
Rated surge voltage	1 kV

Connection data

Connection technology: In-/Outputs	8 x CAGE CLAMP®
Connection type (1)	Inputs/Outputs
Solid conductor	0.25 ... 2.5 mm ² / 24 ... 14 AWG
Fine-stranded conductor	0.25 ... 2.5 mm ² / 24 ... 14 AWG
Strip length	8 ... 9 mm / 0.31 ... 0.35 inch

Geometrical Data

Width	12 mm / 0.472 inch
Height	67.8 mm / 2.669 inch
Height from upper-edge of DIN-35 rail	60.6 mm / 2.386 inch
Depth	100 mm / 3.937 inch

Mechanical data

Type of mounting	DIN-35 rail
------------------	-------------

Material Data

Housing material	Polycarbonate, polyamide 6.6
Weight	48.5 g
Conformity marking	1

Environmental Requirements





Surrounding air (operating) temperature	-40 ... 70 °C
Surrounding air (storage) temperature	-40 ... 85 °C
Protection class	IP20
Degree of pollution (5)	2 per IEC 61131-2
Operating altitude	without temperature derating: 0 ... 2000 m; with temperature derating: 2000 ... 5000 m (0.5 K/100 m); max.: 5000 m
Mounting position	horizontal (standing/lying) or vertical
Relative air humidity (no condensation)	95 %
Relative humidity	Short-term condensation per Class 3K7/IEC EN 60721-3-3 and E DIN 40046-721-3 (except wind-driven precipitation, water and ice formation)
Vibration resistance	acc. to IEC 60068-2-6 (acceleration: 5g), EN 60870-2-2, IEC 60721-3-1, -3, EN 50155, EN 61373
Shock resistance	acc. to IEC 60068-2-27 (15g/11 ms/half-sine/1000 shocks; 25g/6 ms /1000 shocks), EN 50155, EN 61373
EMC immunity to interference	acc. to EN 61000-6-1, -2, EN 61131-2, marine applications, EN 50121-3-2, -4, -5, EN 60255-26, EN 60870-2-1, EN 61850-3, IEC 61000-6-5, IEEE 1613, VDEW: 1994
EMC emission of interference	acc. to EN 61000-6-3, -4, EN 61131-2, EN 60255-26, marine applications, EN 60870-2-1, EN 61850-3, EN 50121-3-2, EN 50121-4, -5
Exposure to pollutants	Per IEC 60068-2-42 and IEC 60068-2-43
Permissible H ₂ S contaminant concentration at a relative humidity 75 %	10 ppm
Permissible SO ₂ contaminant concentration at a relative humidity 75 %	25 ppm

Commercial data

Country of origin	DE
GTIN	4055143353625
Customs Tariff No.	85389099990

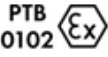
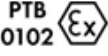
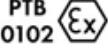
Approvals / Certificates

Ex-Approvals

Logo	Approval	Additional Approval Text	Certificate name
	ATEX TUEV Nord Cert GmbH	EN 60079-0	TUEV 17 ATEX 193969X
	ATEX TUEV Nord Cert GmbH	EN 60079-0	TUEV 17 ATEX 193969X
	ATEX TUEV Nord Cert GmbH	EN 60079-0	TUEV 17 ATEX 193969X
	IECEX TUEV Nord Cert GmbH	IEC 60079-0	IECEX TUN 16.0046X
	IECEX TUEV Nord Cert GmbH	IEC 60079-0	IECEX TUN 16.0046X
	IECEX TUEV Nord Cert GmbH	IEC 60079-0	IECEX TUN 16.0046X
	UL Underwriters Laboratories Inc. (HAZARDOUS LOCATIONS)	ANSI/ISA 12.12.01	E198726 Sec.1

Country specific Approvals

Logo	Approval	Additional Approval Text	Certificate name
	KC National Radio Research Agency	Article 58-2, Clause 3	MSIP- REM-W43- AIM750





KC
National Radio Research Agency

Article 58-2, Clause 3

MSIP-
REM-W43-
AIM750

Ship Approvals



Logo	Approval	Additional Approval Text	Certificate name
	LR Lloyds Register	-	17/20073 LR
	PRS Polski Rejestr Statków	-	TE/2215 /880590 /18















UL-Approvals

Logo	Approval	Additional Approval Text	Certificate name
	UL UL International Netherlands B.V. (ORDINARY LOCATIONS)	UL 508	E175199 Sec.1

Compatible products

Marking accessories

	Item no.: 2009-145 Mini-WSB Inline; for Smart Printer; on reel; stretchable 5 - 5.2 mm; plain; snap-on type		2009-145
	Item no.: 2009-145/000-002 Mini-WSB Inline; for Smart Printer; on reel; stretchable 5 - 5.2 mm; plain; snap-on type		2009-145 /000-002
	Item no.: 2009-145/000-005 Mini-WSB Inline; for Smart Printer; on reel; stretchable 5 - 5.2 mm; plain; snap-on type		2009-145 /000-005

	Item no.: 2009-145/000-006 Mini-WSB Inline; for Smart Printer; on reel; stretchable 5 - 5.2 mm; plain; snap-on type	2009-145 /000-006
	Item no.: 2009-145/000-007 Mini-WSB Inline; for Smart Printer; on reel; stretchable 5 - 5.2 mm; plain; snap-on type	2009-145 /000-007
	Item no.: 2009-145/000-012 Mini-WSB Inline; for Smart Printer; on reel; stretchable 5 - 5.2 mm; plain; snap-on type	2009-145 /000-012
	Item no.: 2009-145/000-023 Mini-WSB Inline; for smartPRINTER; on reel; stretchable 5 - 5.2 mm; plain; snap-on type	2009-145 /000-023
	Item no.: 2009-145/000-024 Mini-WSB Inline; for Smart Printer; on reel; stretchable 5 - 5.2 mm; plain; snap-on type	2009-145 /000-024
	Item no.: 248-501 Miniature WSB Quick marking system; plain; Marker width 5 mm; 10 strips with 10 markers per card	248-501
	Item no.: 248-501/000-002 Mini-WSB marking card; as card; not stretchable; plain; snap-on type	248-501 /000-002
	Item no.: 248-501/000-005 Mini-WSB marking card; as card; not stretchable; plain; snap-on type	248-501 /000-005
	Item no.: 248-501/000-006 Mini-WSB marking card; as card; not stretchable; plain; snap-on type	248-501 /000-006
	Item no.: 248-501/000-007 Mini-WSB marking card; as card; not stretchable; plain; snap-on type	248-501 /000-007
	Item no.: 248-501/000-012 Mini-WSB marking card; as card; not stretchable; plain; snap-on type	248-501 /000-012
	Item no.: 248-501/000-017 Mini-WSB marking card; as card; not stretchable; plain; snap-on type	248-501 /000-017
	Item no.: 248-501/000-023 Mini-WSB marking card; as card; not stretchable; plain; snap-on type	248-501 /000-023
	Item no.: 248-501/000-024 Mini-WSB marking card; as card; not stretchable; plain; snap-on type	248-501 /000-024
	Item no.: 750-103 Group marker carrier	750-103



Item no.: 750-107
Group marker carrier

750-107

system box



Item no.: 850-804
IP65 enclosure; Stainless steel; WxHxD (400x123x200 mm); 4 x M20, 16 x M16, 28 x M12 cable grip

850-804



Item no.: 850-804/000-001
IP65 enclosure; Stainless steel; WxHxD (400x123x200 mm); 2 x M20, 13 x M16, 32 x M12 cable grip

/000-001

850-804



Item no.: 850-805
IP65 enclosure; Stainless steel; WxHxD (600x123x200 mm); 4 x M20, 19 x M16, 67 x M12 cable grip

850-805



Item no.: 850-814/002-000
IP65 enclosure; Sheet steel (RAL 7035); WxHxD (200x120x200 mm); without flange plate

/002-000

850-814



Item no.: 850-815/002-000
IP65 enclosure; Sheet steel (RAL 7035); WxHxD (300x120x200 mm); without flange plate

/002-000

850-815



Item no.: 850-816/002-000
IP65 enclosure; Sheet steel (RAL 7035); WxHxD (400x120x200 mm); without flange plate

/002-000

850-816



Item no.: 850-817/002-000
IP65 enclosure; Sheet steel (RAL 7035); WxHxD (600x120x200 mm); without flange plate

/002-000

850-817



Item no.: 850-825
IP65 enclosure; Aluminium (RAL 7032); WxHxD (160x100x160 mm); 9 x M12, 4 x M20

850-825



Item no.: 850-826
IP65 enclosure; Aluminium (RAL 7032); WxHxD (240x100x160 mm); 4 x M20, 4 x M16, 14 x M12 cable grip

850-826



Item no.: 850-826/002-000
IP65 enclosure; Aluminium (RAL 7035); WxHxD (240x100x160 mm); 4 x M20, 4 x M16, 14 x M12 cable grip

/002-000

850-826



Item no.: 850-827
IP65 enclosure; Aluminium (RAL 7032); WxHxD (320x100x160 mm); 4 x M20, 8 x M16, 17 x M12 cable grip

850-827



Item no.: 850-827/002-000
IP65 enclosure; Aluminium (RAL 7035); WxHxD (320x100x160 mm); 4 x M20, 8 x M16, 17 x M12 cable grip

/002-000

850-827



Item no.: 850-828
IP65 enclosure; Aluminium (RAL 7032); WxHxD (480x100x160 mm); 4 x M20, 10 x M16, 35 x M12 cable grip

850-828



Item no.: 850-828/002-000
IP65 enclosure; Aluminium (RAL 7035); WxHxD (480x100x160 mm); 4 x M20, 10 x M16, 35 x M12 cable grip



















/002-000



850-828



Item no.: 850-834
IP65 enclosure; Polyester (RAL 7032); WxHxD (164x100x164 mm); 9 x M12, 4 x M20

850-834

	Item no.: 850-835 IP65 enclosure; Polyester (RAL 7032); WxHxD (244x100x164 mm); 4 x M20, 4 x M16, 14 x M12 cable grip	850-835
	Item no.: 850-836 IP65 enclosure; Polyester (RAL 7032); WxHxD (324x100x164 mm); 4 x M20, 8 x M16, 17 x M12 cable grip	850-836
Carrier rail		
	Item no.: 210-112 Steel carrier rail; 35 x 7.5 mm; 1 mm thick; 2 m long; slotted; according to EN 60715; "Hole width 25 mm	210-112
	Item no.: 210-113 Steel carrier rail; 35 x 7.5 mm; 1 mm thick; 2 m long; unslotted; according to EN 60715	210-113
	Item no.: 210-114 Steel carrier rail; 35 x 15 mm; 1.5 mm thick; 2 m long; unslotted; similar to EN 60715	210-114
	Item no.: 210-115 Steel carrier rail; 35 x 7.5 mm; 1 mm thick; 2 m long; slotted; according to EN 60715; "Hole width 18 mm	210-115
	Item no.: 210-118 Steel carrier rail; 35 x 15 mm; 2.3 mm thick; 2 m long; unslotted; according to EN 60715	210-118
	Item no.: 210-196 Aluminum carrier rail; 35 x 8.2 mm; 1.6 mm thick; 2 m long; unslotted; similar to EN 60715	210-196
	Item no.: 210-197 Steel carrier rail; 35 x 15 mm; 1.5 mm thick; 2 m long; slotted; similar to EN 60715	210-197
	Item no.: 210-198 Copper carrier rail; 35 x 15 mm; 2.3 mm thick; 2 m long; unslotted; according to EN 60715	210-198
	Item no.: 210-504 Steel carrier rail; 35 x 7.5 mm; 1 mm thick; 2 m long; slotted; galvanized; according to EN 60715	210-504
	Item no.: 210-505 Steel carrier rail; 35 x 7.5 mm; 1 mm thick; 2 m long; unslotted; galvanized; according to EN 60715	210-505
	Item no.: 210-506 Steel carrier rail; 35 x 15 mm; 1.5 mm thick; 2 m long; unslotted; galvanized; similar to EN 60715	210-506
	Item no.: 210-508 Steel carrier rail; 35 x 15 mm; 1.5 mm thick; 2 m long; slotted; galvanized; similar to EN 60715	210-508
shield connection		
	Item no.: 790-108 Shield clamping saddle; 11 mm wide; diameter of compatible conductor	790-108
	Item no.: 790-116 Shield clamping saddle; 19 mm wide; diameter of compatible conductor; 7 ... 16 mm	790-116
	Item no.: 790-124 Shield clamping saddle; 27 mm wide; diameter of compatible conductor; 6 ... 24 mm	790-124
	Item no.: 790-140 Shield clamping saddle; diameter of compatible conductor	790-140
	Item no.: 790-208 Shield clamping saddle; 12.4 mm wide; 3 ... 8 mm	790-208

	Item no.: 790-216 Shield clamping saddle; 21.8 mm wide; 6 ... 16 mm	790-216
	Item no.: 790-220 Shield clamping saddle; 30 mm wide; 6 ... 20 mm	790-220

Downloads

Documentation

Manual

2-channel, 4 - 20 mA /XTR Diff. measuring input	V 1.1.0	pdf 2.1 MB	Download
--	---------	---------------	----------

Bid Text

750-492/040-001		doc 35.3 kB	Download
-----------------	--	----------------	----------

Additional Information

Disposal; Electrical and electronic equipment, Packaging	V 1.0.0	pdf 265.8 kB	Download
--	---------	-----------------	----------

System Description

System Manual /XTR Basic conditions and recommendations for higher operational safety	V 1.2.0	pdf 2.9 MB	Download
--	---------	---------------	----------

Overview on WAGO-I/O-SYSTEM 750 approvals		pdf 780.2 kB	Download
---	--	-----------------	----------

750 XTR Series I/O-System – General Product Information		pdf 1.1 MB	Download
---	--	---------------	----------

CAD/CAE - Smart Data

CAD data

3D Download 750-492/040-001		URL	Download
-----------------------------	--	-----	----------



Product family

750 XTR Series – I/O System

I/O-System 750 XTR: Dort automatisieren, wo jedes andere System an seine Grenzen stößt – und das zuverlässig und wirtschaftlich! XTR – dieses Kürzel im Systemnamen steht für extremen Schutz vor klimatischen Einflüssen, Schwingungen, Erschütterungen und Überspannungen.

[Learn more about the product family.](#)

[Show all products from the family](#)